



**TERMA**

SINCE 1990

## Tune VWS

DRY MINT // 1800 — 490 // 50 mm connection valve + “Slim” thermostatic head

LUX

## Tune VWD

DRY MINT // 1800 — 290 // 50 mm connection valve + “Slim” thermostatic head

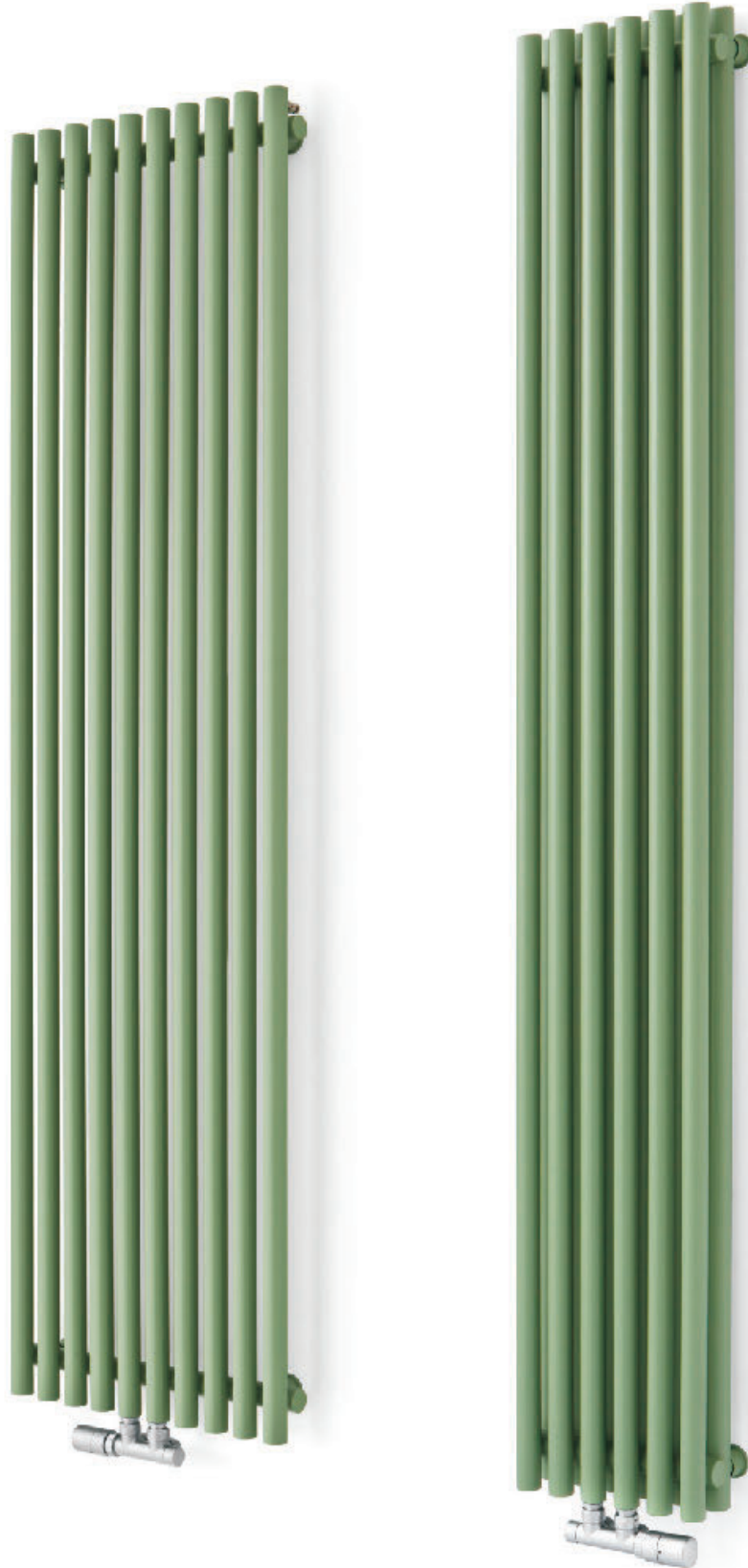

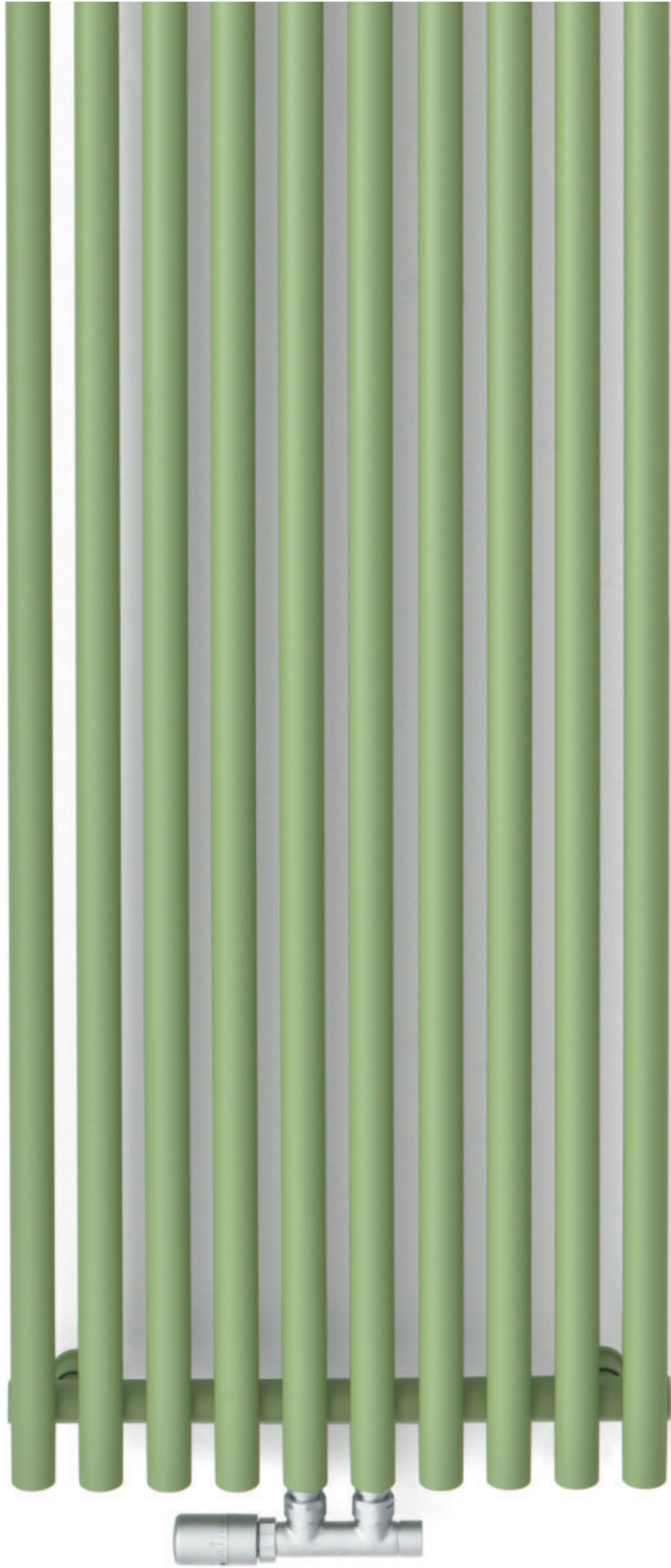

VWS



Standard connections:

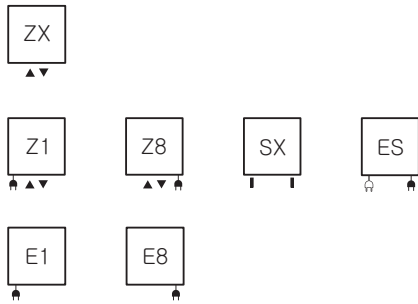

Sizes available:

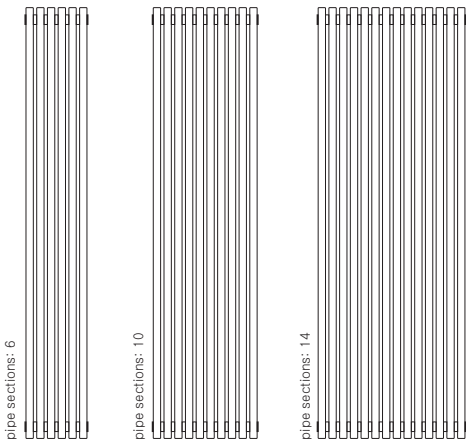

VWD



Standard connections:

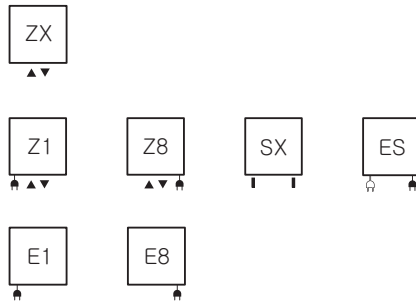

Sizes available:

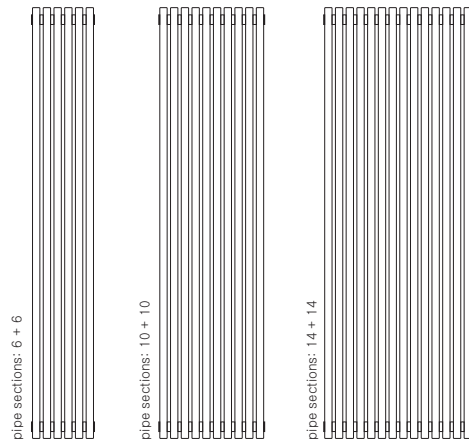

A	B	C	C'	$\frac{75^\circ}{65^\circ}{20^\circ}$	$\frac{55^\circ}{45^\circ}{20^\circ}$		D	E	F		
[mm]	[mm]	[mm]	[mm]	[W]	[W]	[W]	[mm]	[mm]	[mm]	[dm³]	[Kg]
<b>VWS</b>											
1800	290	50	250	638	338	600	190	1700	50	7,8	10,8
1800	490	50	450	1064	563	1000	390	1700	50	13,1	17,8
1800	690	50	650	1490	788	1500	590	1700	50	18,3	24,9
<b>VWS electric version</b>											
1800	290	—	—	—	—	600	190	1600	50	7,8	10,8
1800	490	—	—	—	—	1000	390	1600	50	13,1	17,8
<b>VWD</b>											
1800	290	50	250	967	489	1000	190	1700	50	15,3	20,8
1800	490	50	450	1612	815	1500	390	1700	50	25,4	34,6
1800	690	50	650	2257	1141	—	590	1700	50	35,6	48,3
<b>VWD electric version</b>											
1800	490	—	—	—	—	1000	390	1600	50	13,1	17,8

Tune VWS

ZX

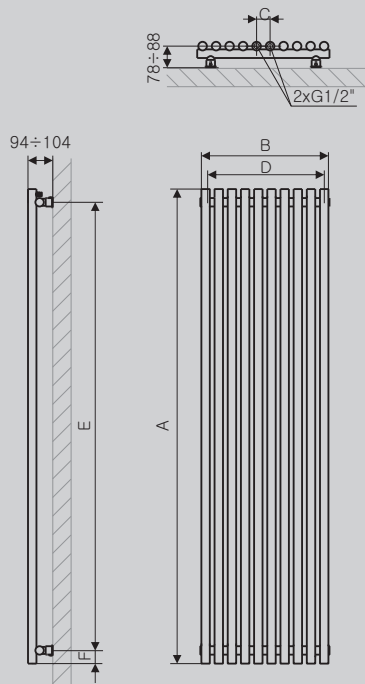

Z1

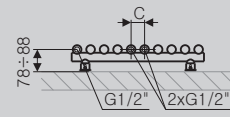

Z8

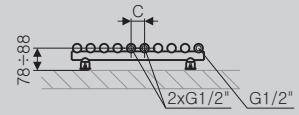

SX

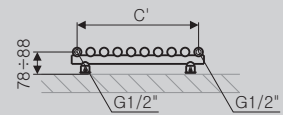

Tune VWD

ZX

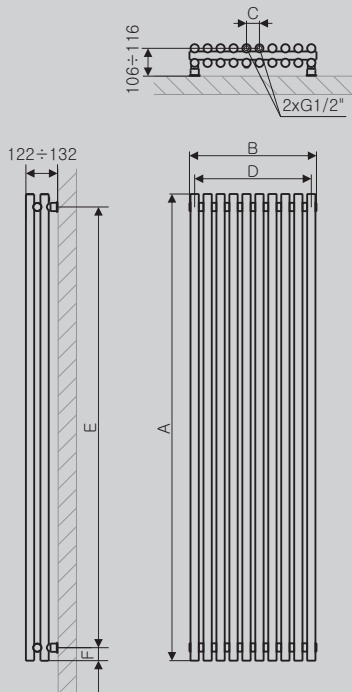

Z1

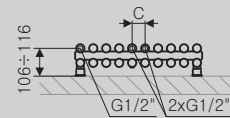

Z8

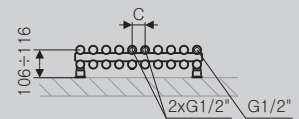

SX

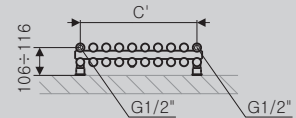

Profile

